

# SEARS

## OWNERS MANUAL

MODEL NO.  
**919.762000**

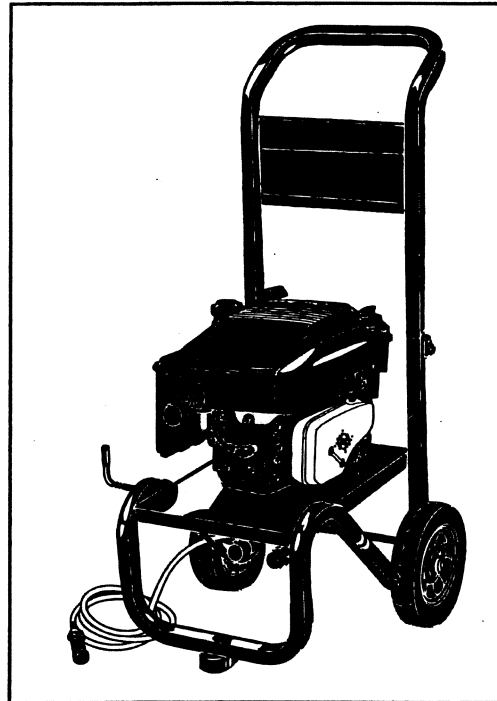

### **CRAFTSMAN.** **6HP 2000 PSI 2 GPM** **HIGH PRESSURE POWER WASHER**

## **WARNING**

**Read Owner's Manual. Do not operate equipment until you have read Owners Manual for Safety, Operation, and Maintenance Instructions.**

- This product is not equipped with a spark arresting muffler. If the product will be used around flammable materials, or on land covered with materials such as agricultural crops, forest, brush, grass, or other similar items, then an approved spark arrester must be installed and is legally required in the state of California. It is a violation of California statutes section 130050 and/or sections 4442 and 4443 of the California Public Resources Code, unless the engine is equipped with a spark arrester, as defined in section 4442, and maintained in effective working order. Spark arresters are also required on some U.S. Forest service land and may also be legally required under other statutes and ordinances.

Engine exhaust from this product contains chemicals known, in certain quantities, to cause cancer, birth defects or other reproductive harm.

**Sears, Roebuck and Co., Hoffman Estates, IL 60179 U.S.A.**

# TABLE OF CONTENTS

Safety Guidelines .....	3-4
Operating Instructions .....	5
Box Contents .....	6
Assembly Instructions .....	6
Prestart Instructions .....	7
Starting Instructions .....	7
High Pressure Instructions .....	8
Using Soap/Chemicals .....	8
Nozzle Cleaning .....	8
Trouble Shooting .....	9
Pump Breakdown .....	10
Parts List .....	11
Pressure Washer Breakdown .....	12
Parts List .....	13
Warranty/Repair/Replacement Parts .....	Back Cover

# SAFETY GUIDELINES - DEFINITIONS



<p>This manual contains information that is important for you to know and understand. This information relates to protecting <b>YOUR SAFETY</b> and <b>PREVENTING EQUIPMENT PROBLEMS</b>. To help you recognize this information, we use the symbols to the right. Please read the manual and pay attention to these sections.</p>	<div style="border: 1px solid black; display: inline-block; padding: 2px 5px;"><b>⚠ DANGER</b></div>	<div style="border: 1px solid black; display: inline-block; padding: 2px 5px;"><b>⚠ CAUTION</b></div>
	<p><b>URGENT SAFETY INFORMATION - A HAZARD THAT WILL CAUSE SERIOUS INJURY OR LOSS OF LIFE.</b></p>	<p>Information that you should pay special attention to.</p>
<div style="border: 1px solid black; display: inline-block; padding: 2px 5px;"><b>⚠ WARNING</b></div>	<p><b>IMPORTANT SAFETY INFORMATION - A HAZARD THAT <i>MIGHT</i> CAUSE SERIOUS INJURY OR LOSS OF LIFE.</b></p>	<div style="border: 1px solid black; display: inline-block; padding: 2px 5px;"><b>NOTE</b></div>
		<p>Information for preventing damage to equipment.</p>

## IMPORTANT SAFETY INSTRUCTIONS





• SAVE THESE INSTRUCTIONS •

**⚠ WARNING**

**IMPROPER OPERATION OR MAINTENANCE OF THIS PRODUCT COULD RESULT IN SERIOUS INJURY AND PROPERTY DAMAGE. READ AND UNDERSTAND ALL WARNINGS AND OPERATING INSTRUCTIONS BEFORE USING**

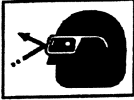
HAZARD	WHAT CAN HAPPEN	HOW TO PREVENT IT
<div style="border: 1px solid black; padding: 5px; text-align: center; margin-bottom: 5px;"> <b>⚠ DANGER</b> </div> <p style="text-align: center;"><b>RISK OF EXPLOSION OR FIRE</b></p> <div style="text-align: center;">  </div>	<ul style="list-style-type: none"> <li>Spilled gasoline and its vapors can become ignited from cigarette sparks, electrical arcing, exhaust gases, and hot engine components such as the muffler.</li> <li>Heat will expand fuel in the tank which could result in spillage.</li> <li>Operating the pressure washer in an explosive environment could result in a fire.</li> <li>Materials placed against or near the pressure washer can interfere with its proper ventilation features causing overheating and possible ignition of the materials.</li> <li>Improperly stored fuel could lead to accidental ignition. Fuel improperly secured could get into the hands of children or other unqualified persons.</li> </ul>	<ul style="list-style-type: none"> <li>Shut off engine and allow it to cool before adding fuel to the tank.</li> <li>Use care in filling tank to avoid spilling fuel. Move pressure washer away from fueling area before starting engine.</li> <li>Keep maximum fuel level ½" below top of tank to allow for expansion.</li> <li>Operate and fuel equipment in well ventilated areas free from obstructions. Equip areas with fire extinguishers suitable for gasoline fires.</li> <li>Never operate pressure washer in an area containing dry brush or weeds.</li> <li>Store fuel in container approved for gasoline, in a secure location away from work area.</li> </ul>
<div style="border: 1px solid black; padding: 5px; text-align: center; margin-bottom: 5px;"> <b>⚠ DANGER</b> </div> <p style="text-align: center;"><b>RISK TO BREATHING</b></p> <div style="text-align: center;">  </div>	<ul style="list-style-type: none"> <li>Breathing exhaust fumes will cause serious injury or death.</li> <li>Some cleaning fluids contain substances which could cause injury to skin, eyes, or lungs.</li> </ul>	<ul style="list-style-type: none"> <li>Operate pressure washer in a well ventilated area. Avoid enclosed areas such as garages, basements, etc.</li> <li>Never operate unit in a location occupied by humans or animals.</li> <li>Use only cleaning fluids specifically recommended for high pressure washers. Follow manufacturers recommendations.</li> </ul>
<div style="border: 1px solid black; padding: 5px; text-align: center; margin-bottom: 5px;"> <b>⚠ WARNING</b> </div> <p style="text-align: center;"><b>RISK OF UNSAFE OPERATION</b></p> <div style="text-align: center;">  </div>	<ul style="list-style-type: none"> <li>Unsafe operation of your pressure washer could lead to serious injury or death to you or others.</li> <li>The spray gun/wand is a powerful cleaning tool that could look like a toy to a child.</li> <li>Reactive force of spray will cause gun/wand to move, and could cause the operator to slip or fall, or misdirect the spray. Improper control of gun/wand can result in injuries to self and others.</li> </ul>	<ul style="list-style-type: none"> <li>Become familiar with the operation and controls of the pressure washer.</li> <li>Keep children away from the pressure washer at all times.</li> <li>Never defeat the safety features of this product.</li> <li>Do not operate machine with missing, broken, or unauthorized parts.</li> <li>Never leave wand unattended while unit is running.</li> <li>Keep work area free of obstacles.</li> <li>Stand on a stable surface and grip gun/wand firmly. Expect the gun to kick when triggered.</li> </ul>

# IMPORTANT SAFETY INSTRUCTIONS (cont'd)

HAZARD	WHAT CAN HAPPEN	HOW TO PREVENT IT
<p><b>⚠ WARNING</b></p> <p><b>RISK OF INJURY FROM SPRAY</b></p> 	<ul style="list-style-type: none"> <li>• High velocity fluid spray can cause objects to break, propelling particles at high speed.</li> <li>• Light or unsecured objects can become hazardous projectiles.</li> </ul>	<ul style="list-style-type: none"> <li>• Always wear ANSI approved Z87 safety glasses. Wear protective clothing to protect against accidental spraying.</li> <li>• Never point wand at, or spray people or animals.</li> <li>• Always secure trigger lock when wand is not in service to prevent accidental operation.</li> <li>• Never permanently secure trigger in pull back (open) position.</li> </ul>
<p><b>⚠ WARNING</b></p> <p><b>RISK OF ELECTRICAL SHOCK</b></p> 	<ul style="list-style-type: none"> <li>• Spray directed at electrical outlets or switches, or objects connected to an electrical circuit, could result in a fatal electrical shock.</li> </ul>	<ul style="list-style-type: none"> <li>• Unplug any electrically operated product before attempting to clean it. Direct spray away from electric outlets and switches.</li> </ul>
<p><b>⚠ WARNING</b></p> <p><b>RISK TO FLUID INJECTION</b></p> 	<ul style="list-style-type: none"> <li>• Your washer operates at fluid pressures and velocities high enough to penetrate human and animal flesh, which could result in amputation or other serious injury. Leaks caused by loose fittings or worn or damaged hoses can result in injection injuries. <b>DO NOT TREAT FLUID INJECTION AS A SIMPLE CUT!</b> See a physician immediately!</li> <li>• Relieve system pressure before attempting maintenance or disassembly of equipment.</li> </ul>	<ul style="list-style-type: none"> <li>• Never place hands in front of nozzle.</li> <li>• Direct spray away from self and others.</li> <li>• Make sure hose and fittings are tightened and in good condition. Never hold onto the hose or fittings during operation.</li> <li>• Do not allow hose to contact muffler.</li> <li>• Never attach or remove wand or hose fittings while system is pressurized.</li> <li>• Use only hose and high pressure accessories rated for 2000 PSI service.</li> <li>• To relieve system pressure, shut off engine, turn off water supply, and pull gun trigger until water stops flowing.</li> </ul>
<p><b>⚠ WARNING</b></p> <p><b>RISK OF CHEMICAL BURN</b></p> 	<ul style="list-style-type: none"> <li>• Use of acids, toxic or corrosive chemicals, poisons, insecticides, or any kind of flammable solvent with this product could result in serious injury or death.</li> </ul>	<ul style="list-style-type: none"> <li>• Do not use acids, gasoline, kerosene, or any other flammable materials in this product. Use only household detergents, cleaners and degreasers recommended for use in pressure washers.</li> <li>• Wear protective clothing to protect eyes and skin from contact with sprayed materials.</li> </ul>
<p><b>⚠ WARNING</b></p> <p><b>RISK OF HOT SURFACES</b></p> 	<ul style="list-style-type: none"> <li>• Contact with hot surfaces, such as engines exhaust components, could result in serious burn.</li> </ul>	<ul style="list-style-type: none"> <li>• During operation, touch only the control surfaces of the pressure washer. Keep children away from the pressure washer at all times. They may not be able to recognize the hazards of this product.</li> </ul>

## GLOSSARY

**PSI:** Unit of measure, pounds per square inch.

**FLOW RATE:** This is the amount of water that passes through your wand. (Usually measured in G.P.M., gallons per minute).

**PRESSURE WASHER PUMP:** Delivers high water pressure. Pressure washer pump is shipped **with** oil. No oil should be added to this pump.

**Engine:** Gasoline powered engine drives pump. Engine is shipped **with** oil. See Manufacturer's Owner's Manual for oil recommendations.

## ⚠ CAUTION

Operating unit with water supply shut-off without flow of water will result in equipment damage.

**BYPASS MODE:** This pertains to the time that the pressure washer is running without the trigger on the gun engaged to spray. You should never run this pressure washer for more than 2 minutes without pulling the trigger to allow cool water to enter the pump and the heated (recirculated) water to exit. Running the pressure washer with water supply shut-off would void your warranty.

## ⚠ CAUTION

THE POWERFUL SPRAY FROM YOUR PRESSURE WASHER IS CAPABLE OF CAUSING DAMAGE TO FRAGILE SURFACES SUCH AS; WOOD, GLASS, AUTOMOBILE PAINT, AUTO STRIPPING AND TRIM, AND DELICATE OBJECTS SUCH AS FLOWERS AND SHRUBS. BEFORE SPRAYING, CHECK THE ITEM TO BE CLEANED TO ASSURE YOURSELF THAT IT IS ROBUST ENOUGH TO RESIST DAMAGE FROM THE FORCE OF THE SPRAY. AVOID THE USE OF THE CONCENTRATED SPRAY STREAM EXCEPT FOR VERY STRONG SURFACES LIKE CONCRETE AND STEEL.

OPERATING UNIT WITH WATER SUPPLY SHUT-OFF WITHOUT FLOW OF WATER WILL RESULT IN EQUIPMENT DAMAGE. YOU SHOULD NEVER RUN THIS PRESSURE WASHER FOR MORE THAN 2 MINUTES WITHOUT PULLING THE TRIGGER TO ALLOW COOL WATER TO ENTER THE PUMP AND THE HEATED (RECIRCULATED) WATER TO EXIT. RUNNING THE PRESSURE WASHER WITH WATER SUPPLY SHUT-OFF WOULD VOID YOUR WARRANTY.

## OPERATING INSTRUCTIONS

### Quick Reference Guide

Everything Below is Detailed  
in this Manual — Please See  
Reference Pages Noted Below

#### STEP 1 ASSEMBLY INSTRUCTIONS

(Reference Below Right)

- Connect Handle to Frame
- Connect Wand to Gun
- Attach High Pressure Hose
- Attach Water Source (Garden Hose)

#### STEP 2 PRESTART INSTRUCTIONS

(Reference Page 5)

- Fill Gas Tank
- Check Engine Oil
- Turn Water Source On
- Check for Leaks

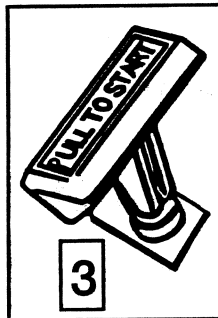
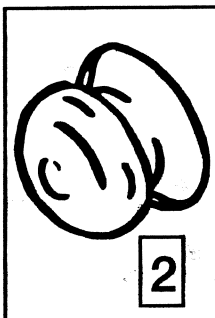
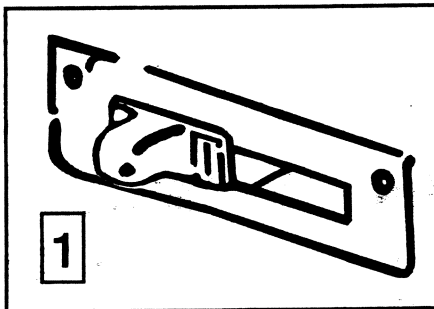

#### STEP 3 STARTING INSTRUCTIONS

(Reference Page 5)

- 1 SLIDETHROTTLECONTROL  
TORUN POSITION
- 2 PUSH PRIMER BULB 3 TIMES-WAIT  
2 SECONDS BETWEEN EACH PUSH
- 3 PULL START  
(NOTE: If engine doesn't  
start right away, trigger  
gun to depressurize the unit)

HELPLINE:

1-800-488-1222

# BOX CONTENTS

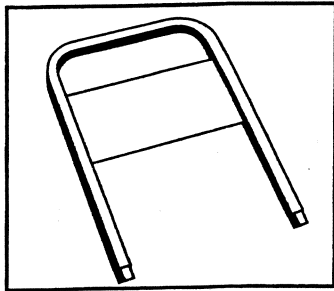

Handle

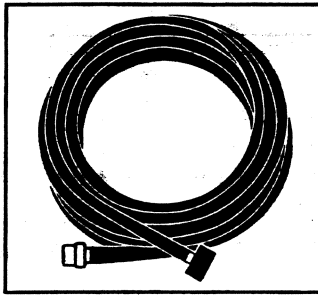

Hose

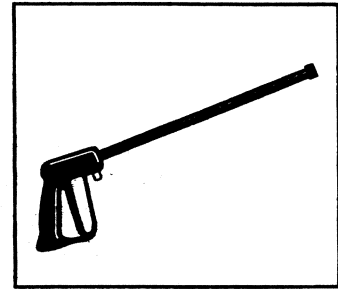

Gun

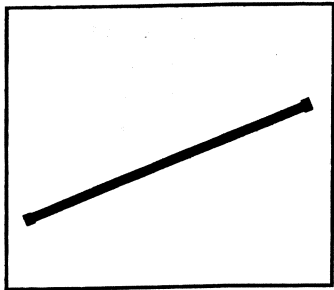

Wand/Nozzle

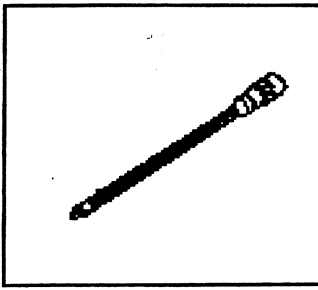

Wand, Rotary

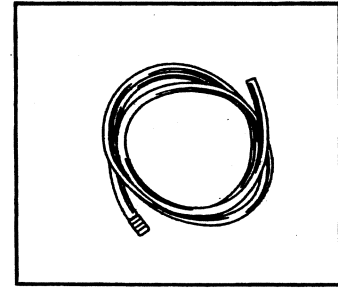

Chemical Hose

## ASSEMBLY INSTRUCTIONS

### STEP #1

**Connect Handle  
to Frame**

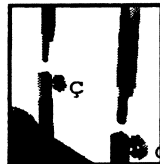

Tighten  
Knob  
by Turning

### STEP #2

**Connect Wand  
to Gun**



Turn  
Knob  
Clock-  
wise

### STEP #3

**Attach High  
Pressure  
Hose**

Attach High Pressure  
Hose Twist Connect to  
the Discharge Fitting  
on the Machine.

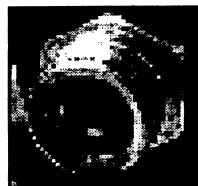

Discharge Fitting

### STEP #4

**Attach Water  
Source  
(Garden Hose)**



Front View  
Garden  
Hose  
Connection

# PRESTART INSTRUCTIONS

## STEP #1

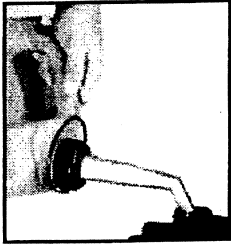

### Fill Gas Tank

Use Gasoline Only!

**DO NOT** Use  
2 Cycle  
(Gasoline and Oil Mix)

## STEP #2

### Check Engine Oil

Engine Uses  
30 Weight —  
Detergent Oil

- Be sure the engine is in a level position.
- Remove the oil filler cap.
- To check oil level, check to ensure oil is to full mark on the dipstick.
- If the level is low, add oil to the full mark with 30 weight detergent oil.
- Reinstall the oil filler cap/dipstick.

## STEP #3



### Turn Water Source On

## STEP #4

### Check for Leaks



*Leaking from Water Inlet Source  
Does Not Affect Performance*

**If leaks are present tighten fittings  
and check or replace o-rings**

**IMPORTANT:** Running the engine with a low oil level can cause engine damage.

# STARTING INSTRUCTIONS

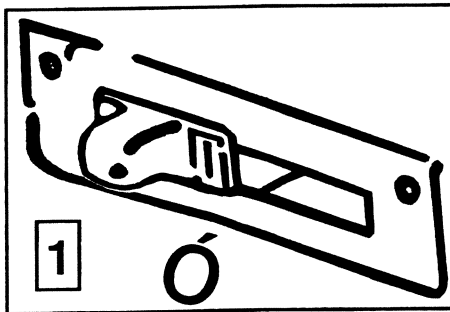

**1** SLIDE THROTTLE CONTROL  
TO RUN POSITION

**2** PUSH PRIMER BULB  
3 TIMES-WAIT 2 SECOND  
BETWEEN EACH PUSH

**3** PULL START  
(NOTE: If engine doesn't  
start right away, trigger gun  
to depressurize the unit)

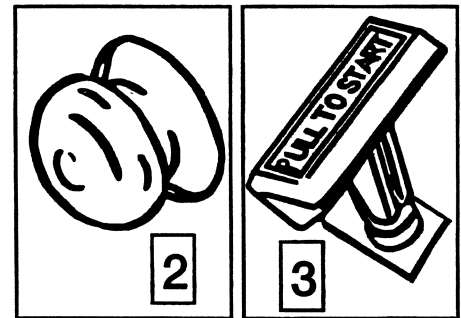

**DO NOT** Leave the Trigger Disengaged  
with the Engine Running For More than  
Two (2) Minutes, This Can Cause Serious  
Damage to Your Pump.

If engine will not restart after  
use, release the pressure build  
up by depressing the trigger gun

## SPECIFICATIONS: Model 919.762000

- Operating Pressure 2000 PSI • Gallons Per Minute — 2 GPM
- Engine: 6.0 HP Craftsman • Pump: Wobble Plate Oil Bath
- Chemical Injection - Under L
- Hose: 1/4" x 25' • Gun: Trigger Control
- Wheels: Two 8" Semi-Pneumatic

# HIGH PRESSURE INSTRUCTIONS

*Push Nozzle Forward  
for Low Pressure*

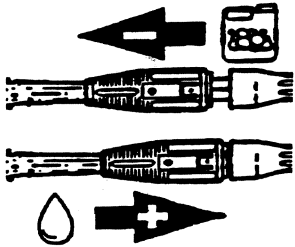

*Pull Back Nozzle  
for High Pressure*

**OPEN (3/8" GAP)  
to Draw Chemical**

***This Pressure  
Washer is Preset at  
the Factory to  
Achieve Maximum  
Pressure at Full  
Throttle***

**CLOSED (1/8" GAP)  
for High Pressure**

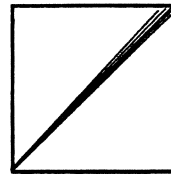

**0° Degree Narrow  
Spray Pattern Greatest  
Cleaning Impact Turn  
Counterclockwise**

**60° Degree Wide  
Spray Pattern Great-  
est Cleaning Coverage  
Turn Clockwise**

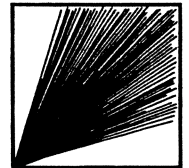

1. The power washer spray pattern may be adjusted by rotating the nozzle head, clockwise or counterclockwise.
2. For the narrowest spray pattern (greatest cleaning impact), rotate nozzle head counterclockwise.
3. For widest spray pattern (greatest cleaning coverage), rotate nozzle head clockwise.

## USING SOAP/CHEMICALS

**Excessive soap concentration does not necessarily improve cleaning power.**



**NOTE:** Follow chemical manufacturer's label & safety directions!

For chemical recommendations specific to your application, contact your local janitorial supply or chemical manufacturer.

Use EX-CELL 5000 (Formulated for EX-CELL Pressure Washers) Or Contact Your Local Janitorial or Chemical Supplier for Recommendations for Your Specific Application.

## NOZZLE CLEANING

1. Remove wand from gun by unscrewing at coupler.
2. Open the adjustable nozzle at the end of the wand to the 0 position by turning counterclockwise. (See Diagram 1). This will allow maximum accessibility to clean the nozzle. Be careful not to damage metal spray fins.
3. Insert the nozzle cleaning wire or straightened paper clip into the nozzle orifice. Move gently in and out to clear blockage from nozzle. (See Diagram 2).
4. Flush water through the nozzle backwards with garden hose.
5. Reattach wand to gun.



**Diagram 1  
Nozzle Fins Open**



**Diagram 2  
Insert Cleaning Tool**



# TROUBLE SHOOTING

SYMPTOM	CAUSE	SOLUTION
Engine won't start	<ul style="list-style-type: none"> <li>Engine throttle is in "OFF" Position</li> <li>Primer bulb hasn't been pushed</li> <li>Pressure build up after initial use</li> </ul>	<ul style="list-style-type: none"> <li>Slide throttle to "Run" position.</li> <li>Push primer bulb 3 times, waiting 2 seconds between pushes.</li> <li>Depress trigger gun</li> </ul>
Won't Draw Chemical	<ul style="list-style-type: none"> <li>Nozzle not in chemical draw position</li> <li>Chemical screen is obstructed</li> <li>Chemical screen not working</li> <li>Chemical injector orifice obstructed or stuck</li> </ul>	<ul style="list-style-type: none"> <li>Push nozzle forward at end of wand.</li> <li>Check chemical screen, clean of obstructed.</li> <li>Make sure chemical screen is submerged in chemical/ water</li> <li>Check and clean</li> </ul>
Pump running normally but pressure does not achieve rated values.	<ul style="list-style-type: none"> <li>Water supply restricted</li> <li>Nozzle is in low PSI position</li> <li>Nozzle incorrect or worn</li> <li>Pump sucking air</li> <li>Nozzle blocked</li> </ul>	<ul style="list-style-type: none"> <li>Check water supply and filter screen for blockage. Check hoses for blockage, kinks, leaks, etc..</li> <li>Pull nozzle at end of wand back to the high pressure position.</li> <li>Check and replace.</li> <li>Check that hoses and fitting are air tight.</li> <li>Clean nozzle.</li> </ul>
Fluctuating Pressure	<ul style="list-style-type: none"> <li>Pump sucking air</li> <li>Garden hose inlet strainer clogged</li> <li>Worn Seals or Packing.</li> <li>Inadequate water supply.</li> <li>Fouled or dirty inlet or discharge valves.</li> <li>Leaky discharge hose.</li> </ul>	<ul style="list-style-type: none"> <li>Check that hoses and fittings are air tight. Purge air from garden hose.</li> <li>Clean. Check filter frequently.</li> <li>Check and replace</li> <li>Check flow available to pump. Check for excessive heat 145° F</li> <li>Clean inlet and discharge valve assemblies. Replace if damaged.</li> </ul>
Pressure drops after period of normal use	<ul style="list-style-type: none"> <li>Nozzle clogged, partially obstructed</li> <li>Nozzle worn</li> <li>Valves worn, dirty or stuck</li> <li>Worn piston packing</li> </ul>	<ul style="list-style-type: none"> <li>Clean or replace.</li> <li>Check and replace.</li> <li>Check, clean or replace.</li> <li>Check and replace.</li> </ul>
Pump noisy	<ul style="list-style-type: none"> <li>Water too hot</li> <li>Pump sucking air</li> <li>Valves dirty or worn</li> <li>Worn bearings</li> </ul>	<ul style="list-style-type: none"> <li>Reduce temperature below 63° C or 145° F.</li> <li>Check that hoses and fittings are air tight.</li> <li>Check, clean or replace.</li> <li>Check and replace if necessary.</li> </ul>
Presence of water in oil (Oil milky) Water dripping from pump	<ul style="list-style-type: none"> <li>High humidity</li> <li>Piston packing and oil seal worn</li> </ul>	<ul style="list-style-type: none"> <li>Change Oil.</li> <li>Check and replace oil seals.</li> </ul>
Water dripping from pump	<ul style="list-style-type: none"> <li>Fittings Loose</li> <li>O-rings of piston guide or retainer worn</li> <li>Piston packing worn</li> </ul>	<ul style="list-style-type: none"> <li>Tighten</li> <li>Check and replace.</li> <li>Check and replace.</li> </ul>
Oil Dripping	<ul style="list-style-type: none"> <li>Oil seal worn</li> <li>Loose drain plug or worn drain plug o-ring.</li> </ul>	<ul style="list-style-type: none"> <li>Check and replace</li> <li>Tighten drain plug or replace O-ring. Do not over torque.</li> </ul>

# PUMP BREAKDOWN

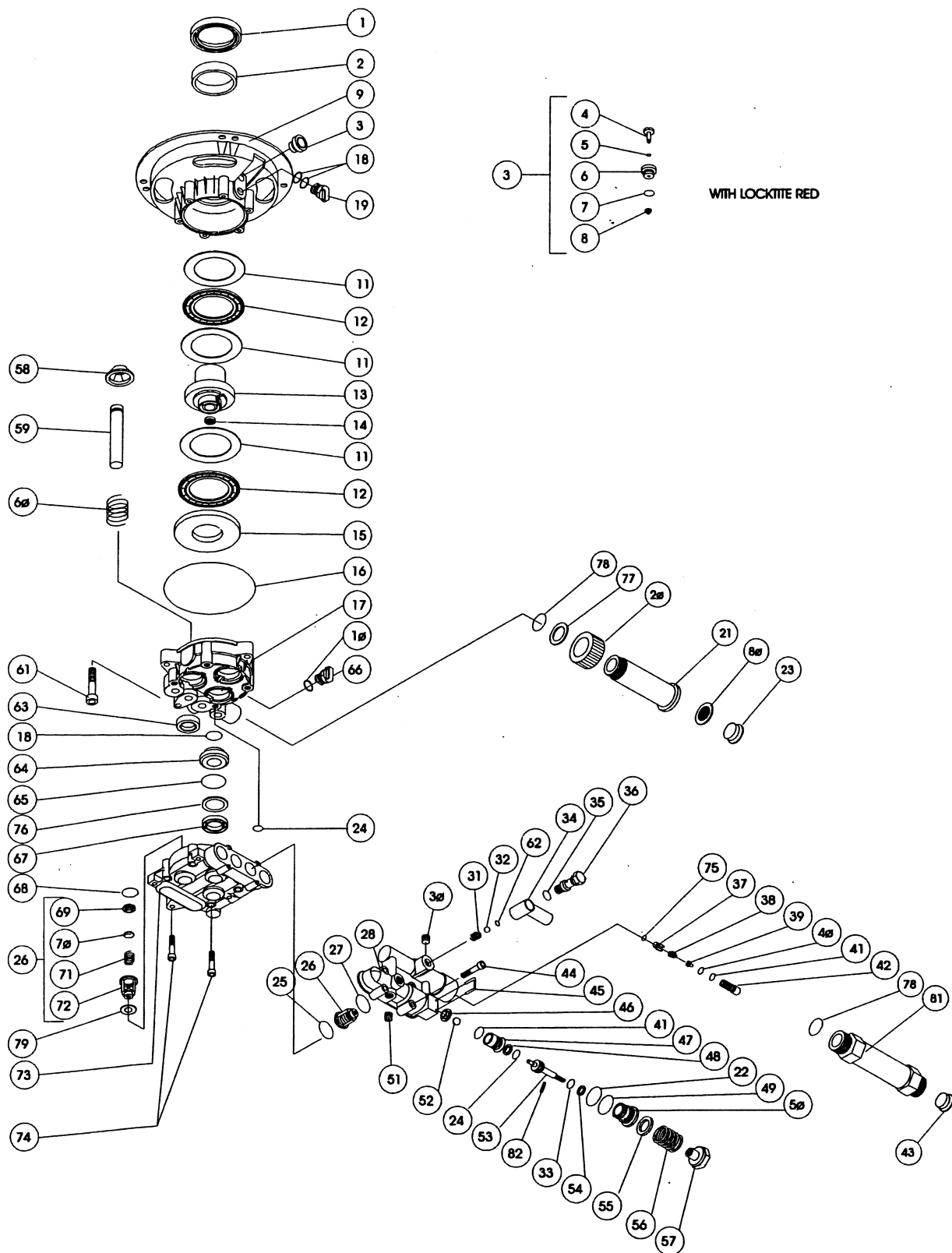

# SERVICE KITS

<u>KEY #</u>	<u>DESCRIPTION</u>	<u>REF.</u>	<u>COMPONENTS</u>	<u>KEY #</u>	<u>DESCRIPTION</u>	<u>REF.</u>	<u>COMPONENTS</u>
16286	OIL SEAL KIT	3	VENTED VALVE	16309	UNLOADERSTEM	22	O-RING [2050]
		10	O-RING [117]			24	O-RING [108]
		16	O-RING [80]			33	O-RING [2025]
		18	O-RING [114]			48	BACK-RING FOR O-RING [108]
		19	OIL SIGHT GLASS			49	O-RING [2056]
		63	OIL SEAL			50	BY-PAS VALVE BODY
16287	PLUNGERKIT	69	OIL FILL CAP	16310	MANIFOLD ASSEMBLY	53	BY-PAS PISTON
		58	RING			54	BACK-RING FOR O-RING [2025]
		59	PISTON			55	SPACER
16288	WOBBLE PLATE/ BEARING KIT	60	SPRING	16302	HEAD, BRASS PUMP	56	PRESSUREREG. SCREW
		11	BEARING DISC			57	PRESSUREREG. NUT
		12	NEEDLE BEARING			82	PIN
		13	WOBBLE PLATE			22	O-RING [2050]
		14	CAP			24	O-RING [108]
16289	INLET EXTENSION KIT	15	BEARING DISC	16311	MANIFOLD	27	O-RING [15X2]
		20	CONNECTION RING NUT			28	MANIFOLD
		21	INLET EXTENSION			30	SCREW
		23	UNDER CAP			31	CHEMICAL SPRING
		77	WASHER			32	BALL STAINLESS STEEL
		78	O-RING [140]			33	O-RING [2025]
16290	OUTLET EXTENSION KIT	80	GASKET W/FILTER	15955	COMPLETE PUMP ASSY.	34	CHEMICAL DOSING BODY
		43	UNDER PLUG			35	O-RING [2031]
		78	O-RING [14X2]			36	CHEMICAL DOSING SCREW
16304	PACKING KIT	81	OUTLET EXTENSION	16302	HEAD, BRASS PUMP	37	NO RETURN VALVE
		65	O-RING [2093]			38	SPRING
		67	O-RING			39	INJECTOR NOZZLE
16305	VALVE KIT	76	O-RING [22X14X1,5]	16311	MANIFOLD	40	O-RING [8X2]
		25	O-RING [2050]			41	O-RING [2037]
		26	VALVE			42	INJECTION NIPPLE
		68	O-RING [12X2]			44	SCREW TCEL [M5X30 12K]
16306	UNLOADER CHECK	79	WASHER	16302	HEAD, BRASS PUMP	45	BY PASS PIN
		37	NO RETURN VALVE			46	VALVE SEAT PLATE
		38	SPRING			47	VALVE SEA
		39	INJECTOR NOZZLE			48	BACK-RING [FOR O-RING 108]
		40	O-RING [8X2]			49	O-RING [2056]
		41	O-RING [2037]			50	BY-PASS VALVE BODY
16307	INJECTOR REPAIR	42	INJECTION NIPPLE	16311	MANIFOLD	51	PLUG
		75	O-RING [5X2]			52	BALL STAINLESS STEEL
		31	CHEMICAL SPRING			53	BY-PAS PISTON
		32	BALL STAINLESS STEEL			54	BACK-RING [FOR O-RING 2025]
		35	O-RING [2031]			55	SPACER
16308	UNLOADER SET	62	O-RING [2015]	16302	HEAD, BRASS PUMP	56	PRESSUREREG. SCREW
		46	VALVE SEAT PLATE			57	PRESSUREREG. NUT
		47	VALVE SEAT			62	O-RING [2015]
		52	BALL STAINLESS STEEL			75	O-RING [5X2]
		41	O-RING [2037]			82	PIN [M2X10]

# PRESSURE WASHER BREAKDOWN

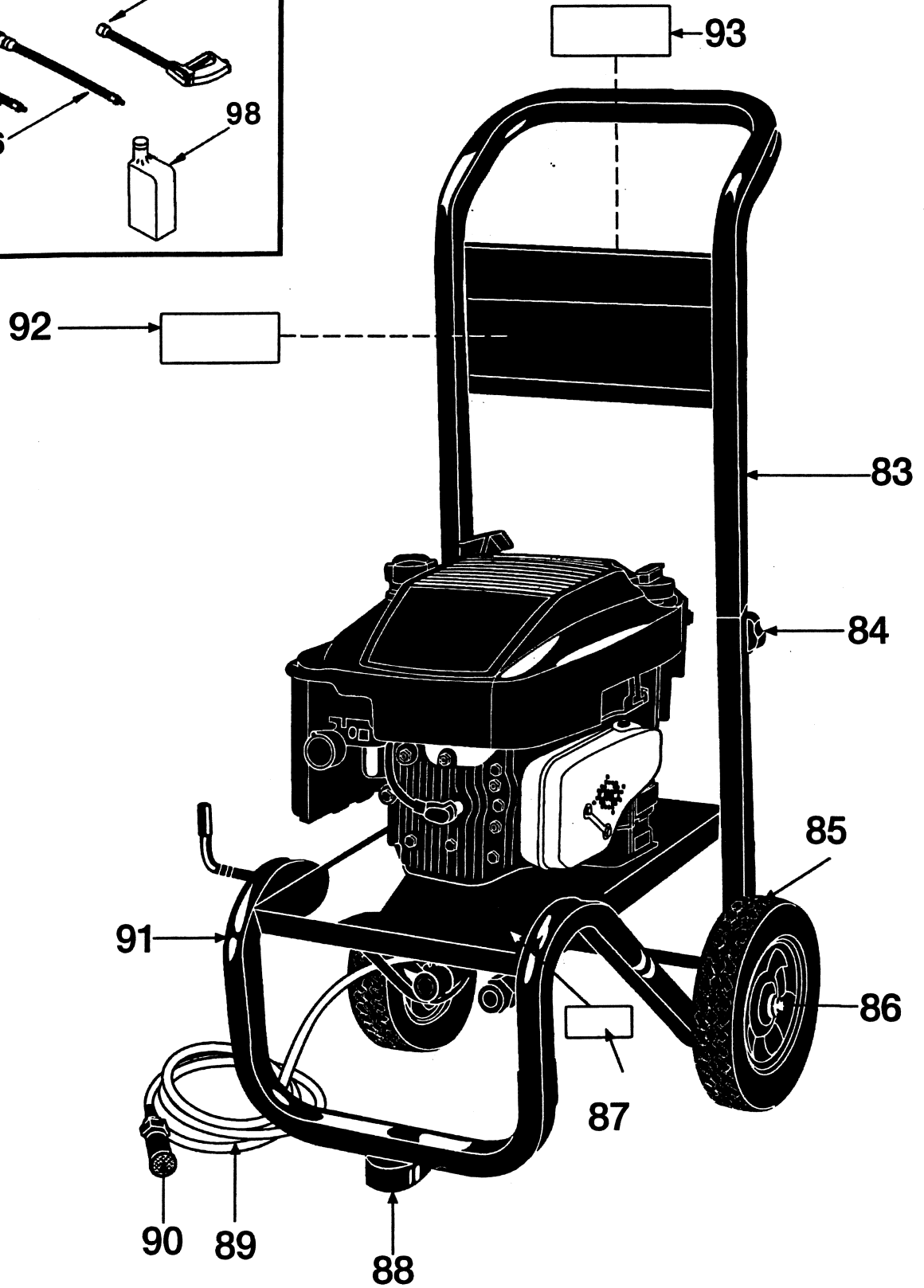
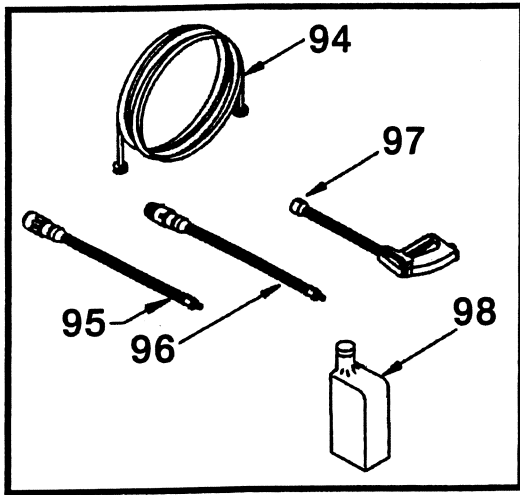

# PARTS LIST

<u>KEY #</u>	<u>PART NUMBER</u>	<u>DESCRIPTION</u>
83	16272	Handle
84	C042	Knob, 5/16
85	15226	Tire, Semi, 8x13/4
86	W137	Nut, Pal, 1/2
87	16303	Label, Hot Surface
88	15223	Foot, 2x1
89	15231	Hose, Chemical
90	15972	Cap, 5/16
91	16273	Frame
92	16257	Label, Craftsman
93	AD187	Label, Warning
94	H040	Hose, 1/4x25 ft.
95	WA100	Wand, Rotary
96	15227	Lance, Multi-Reg.
97	H128	Gun, 1/4 Male
98	16270	Oil, 27 oz., 30 Wt.

**Not Illustrated**

16256

Owners Manual

# SEARS

## OWNERS MANUAL

**MODEL NO.  
919.762000**

When requesting service or ordering parts, always provide the following information:

- Model Number
- Part Number
- Part Description
- Name of Item

### FULL ONE YEAR WARRANTY AIR COMPRESSOR

If this air compressor fails due to a defect in material or workmanship within one year from the date of purchase, RETURN IT TO THE NEAREST SEARS REPAIR CENTER THROUGHOUT THE UNITED STATES AND SEARS WILL REPAIR IT, FREE OF CHARGE.

If this air compressor is used for commercial or rental purposes, the warranty will apply for ninety days from the date of purchase.

This warranty gives you specific legal rights and you may have other rights which vary from state to state.

## CRAFTSMAN. 6HP 2000 PSI 2 GPM HIGH PRESSURE POWER WASHER

For the repair or replacement parts you need

Call 7 am - 7 pm, 7 days a week

**1-800-366-PART**

(1-800-366-7278)



For in-home major brand repair service

Call 24 hours a day, 7 days a week

**1-800-4-REPAIR**

(1-800-473-7247)



For the location of a

Sears Parts and Repair Center in your area

Call 24 hours a day, 7 days a week

**1-800-488-1222**



For information on purchasing a Sears  
Maintenance Agreement or to inquire

about an existing Agreement

call 9 am - 5 pm, Monday-Saturday

**1-800-827-6655**



**SEARS**  
REPAIR SERVICES  
America's Repair Specialists

Sears, Roebuck and Co., Hoffman Estates, IL 60179 U.S.A.